

SEM1603TC USER GUIDE

DIN RAIL MOUNTED TRANSMITTER
 THERMOCOUPLE INPUT
 TWO WIRE (4 to 20) mA OUTPUT

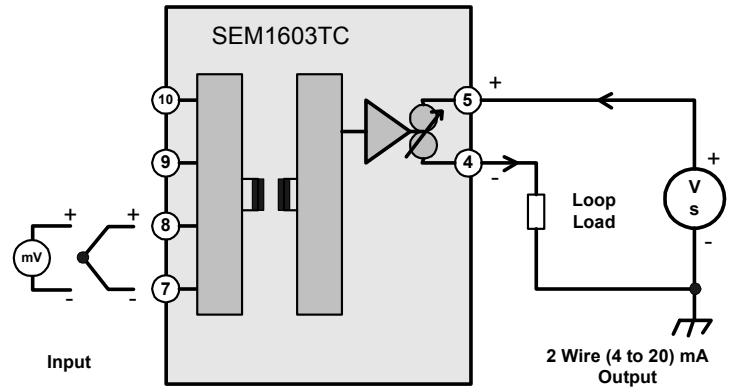

Important - Please read this document before any installing.

Every effort has been taken to ensure the accuracy of this document, however we do not accept responsibility for damage, injury, loss or expense resulting from errors and omissions, and we reserve the right of amendment without notice.



IMPORTANT - CE & SAFETY REQUIREMENTS

Product must be DIN rail mounted, inside a suitable enclosure providing environmental protection to IP65 or greater.

To maintain CE EMC requirements, input wires must be less than 30 metres.

The product contains no serviceable parts, or internal adjustments. no attempt must be made to repair this product. Faulty units must be returned to supplier for repair.

This product must be installed by a qualified person. All electrical wiring must be carried out in accordance with the appropriate regulations for the place of installation.

Before attempting any electrical connection work, please ensure all supplies are switched off.

ABSOLUTE MAXIMUM CONDITIONS (To exceed may cause damage to the unit) :-

Supply Voltage	± 30 V dc (Protected for over voltage and reverse connection)
Current with over voltage	± 200 mA
Input Voltage	± 5 V between any terminals
Input Current	± 100 mA between terminals 7 & 10
Ambient	Temperature (-30 to 75) °C Humidity (10 to 95) % RH (Non condensing)

PRODUCT SPECIFICATION

Please refer to the product data sheet for full specification, available to download at www.status.co.uk.

RECEIVE AND UNPACKING

Please inspect the packaging and instrument thoroughly for any signs of transit damage. If the instrument has been damaged, please notify your supplier immediately.

CONFIGURATION

To Configure device use the USB configurator tool available from your supplier. Connect the configurator to the PC USB port, connect Red wire to terminal 5 and Black wire to terminal 4.

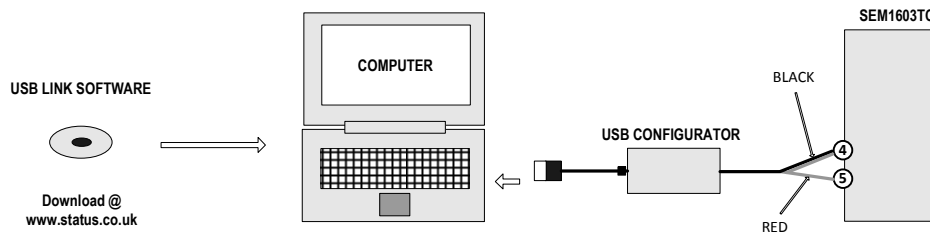

The following parameter can be configured by simply entering as prompted by the software package.

- Input type (K,J,E,N,T,R,S,mV)
- High range
- Low range
- Units (°C, °F, mV)
- Burnout (direction of output current on sensor burnout)

Factory default:
 Input type = K
 High Range = 1000
 Low Range = 0
 Units = °C
 Burnout = UPSCALE

MECHANICAL INSTALLATION

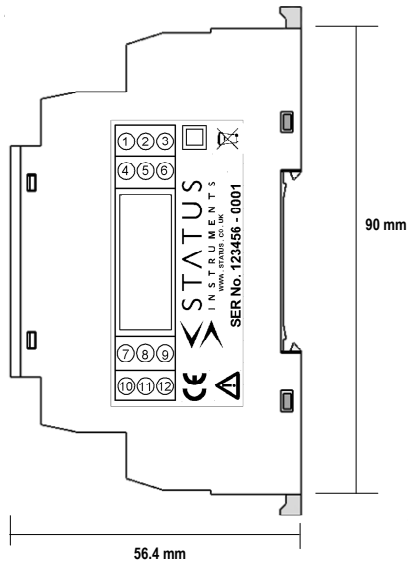
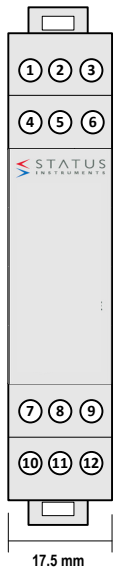

MOUNTING

- ① Screw driver



- ② EN50022 DIN RAIL

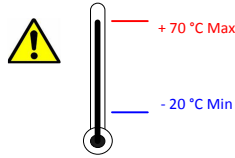
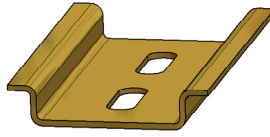

SEM1603 Enclosure

Style	DIN 43880 (1 module width)
Material	Polyamide 6.6 self extinguishing
Terminals	Screw terminal
Cable	2.5 mm Max
Colour	Grey

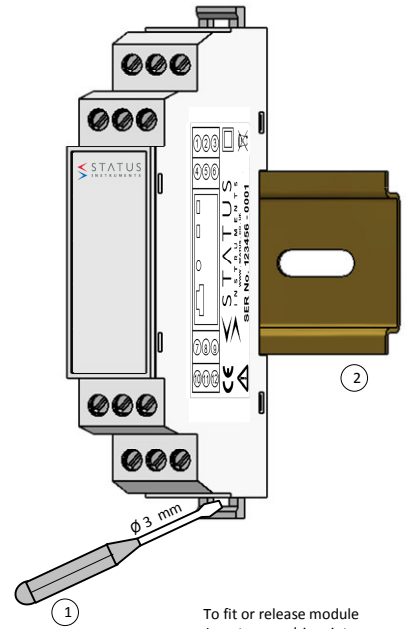

To fit or release module
Insert screw driver into
slot and lever latch
away from body

ELECTRICAL INSTALLATION

Screw Driver

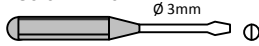

TURN OFF SUPPLY BEFORE WORKING ON ANY ELECTRICAL CONNECTION

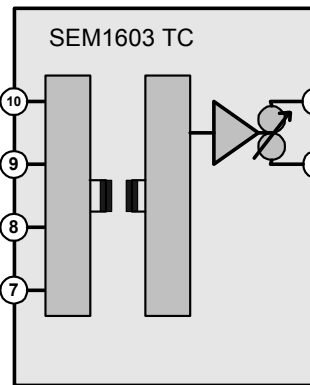
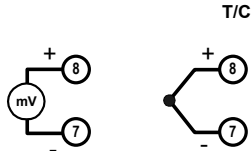

SUPPLY (Vs) = (11 to 30) V dc

MAX LOAD Ohms = $(V_s - 11) / 0.021$

INPUT CONNECTION

For cable lengths < 3 Metres screen or twisted pair is not required
For cable length > 3 Metres and < 30 Metres screen or twisted pair is required
Cable lengths > 30 Metres are not recommended
T/C Inputs must use the correct compensation cable

OUTPUT

2 Wire (4 to 20) mA
Max cable length 1000 Metres
Use twisted pair cable > 30 Metres